



# SPARE PARTS CATALOGUE

## Electric Range



## CONTENTS

### ADULTS

Emicro One	7
Peugeot	11
Micro Falcon	15
Micro Eagle	19
Micro Condor	23
Micro Condor II	27
Micro Explorer	31
Micro Colibri	35
Micro E-Bike	39
Micro Merlin with HB + Merlin	43
Micro Sparrow XL	47
Micro Sparrow	49

**ADULTS**

# EMICRO ONE EM0012

## PARTS

article no.	article
5000	handlebar without grips
5001	handles
5002	handlebar clamp
5003	extension tube
5004	plastic linkage tube
5005	extension tube quick release
5006	lower tube
5007	lower clamp
5008	steering head
5010	aluminum spacer ring (hic)
5011	small fork
5012	small front wheel fender
5013	fender front wheel screws
5015	spacer front wheel
5016	axle front wheel 150mm
5017	shim (left)
5018	shim (right)
5019	push button blue
5020	bolt for shims (left & right)
5021	bolt for holder plates (right)
5022	folding quick release kit
5023	bolt left + right
5024	folding block
5025	M8 countersunk screw folding block left
5026	M8 torx screw
5027	kick stand set

article no.	article
5042	small deck main body v1 for em0004
5043	LED plastic cover
5044	small motor V1 (straight connectors)
5047	griptape
5051	rear PU wheel incl. ( Aluminium hub with PU )
5052	rear wheel screw incl. washer
5094	front rubber wheel
5096	small brake complete set V2
5098	brake magnet
5111	small deck main body v2 for em0012
5182	brake plastic fixture
5183	brake spring
5184	brake pin
5227	screw for lower clamp



EMICRO ONE  
EM0012



# EMICRO ONE EM0012

PARTS

article no.	article
5026	rear wheel screw
5028	protection rim
5029	cover screws M4
5036	hexagon socket flat head screws
5037	controller plastic cylinder
5038	small cable groove protection
5039	thermal pad
5040	alu cover
5055	controller V4 (only motion control)
5100	small cable groove protection V2
5102	charge connector V2
5105	small plastic cover
5119	small o-ring
5125	battery
5185	brake fixation screw
5186	rubber grommet
5234	M8 torx cover screws
AC5202	EU charger
AC5203	UK charger
AC5204	US charger
AC5205	AU charger

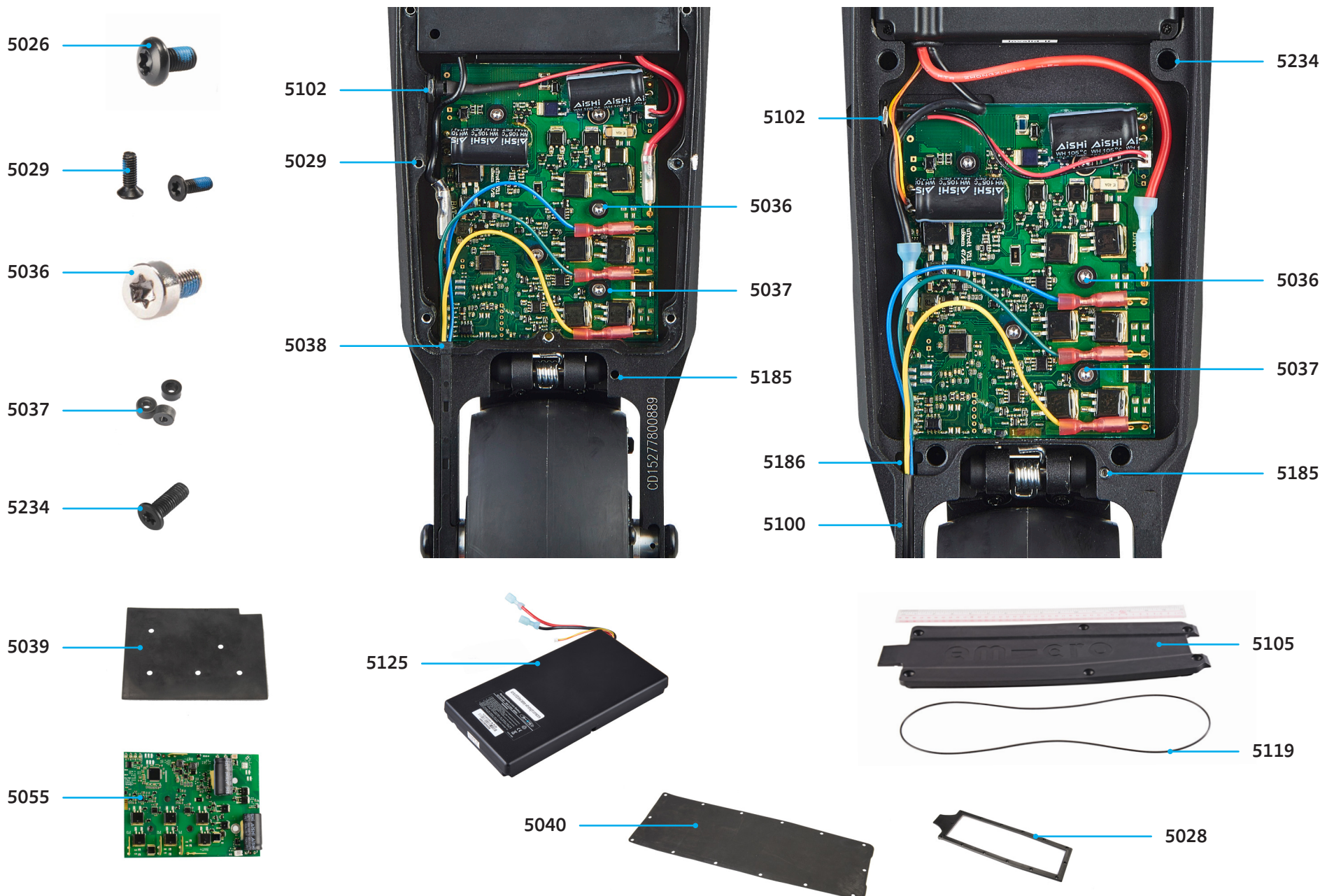

EMICRO ONE  
EM0012

# PEUGEOT EM0006

## PARTS

article no.	article
5015	front spacer
5016	front axle
5019	folding button blue
5025	M8 countersunk screw (kickstand left/main cover)
5026	M8 torx screw
5043	LED plastic cover
5051	rear PU wheel incl. ( aluminium hub with PU )
5052	rear wheel screw incl. washer
5074	handle left
5078	peugeot fronttube
5086	peugeot folding complete
5094	front rubber wheel 145mm
5096	brake complete
5098	brake magnet
5111	small deck main body v2
5114	electric motor with 90° connectors
5117	griptape peugeot
5179	handle right
5180	peugeot click-in tonge
5181	frontpart connector screw
5182	brake plastic fixture
5183	brake spring
5184	brake pin

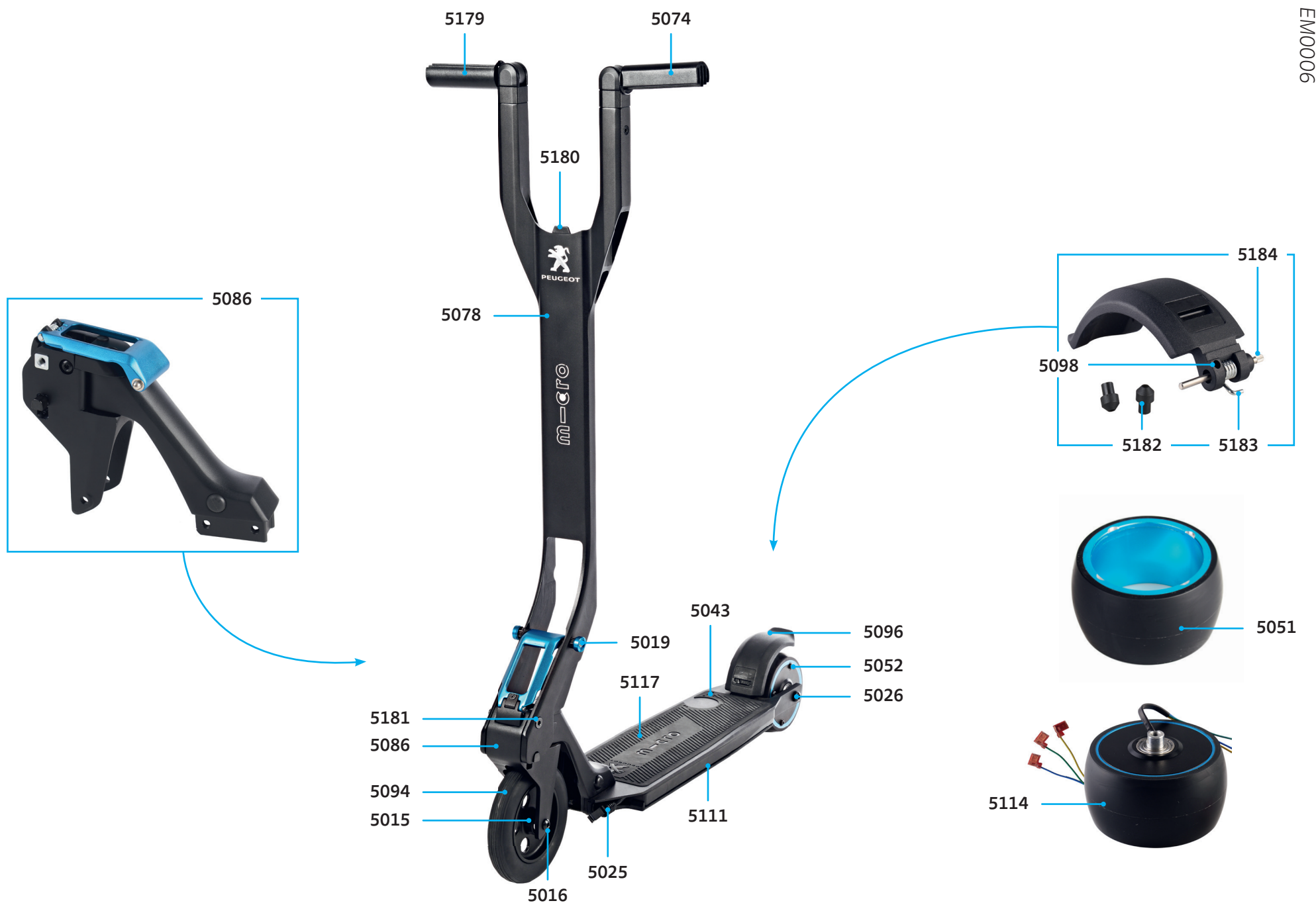

# PEUGEOT EM0006

## PARTS

article no.	article
5026	M8 torx screw
5036	hexagon socket flat head screws (controller screws)
5039	thermal pad
5100	small cable groove protection V2
5102	charge connector V2
5105	small plastic cover
5119	small o ring
5126	battery V3.2
5129	controller V5 with plastic cover
5185	brake fixation screw
5186	motor cable rubber grommet
5234	M8 torx cover screws
AC5202	EU charger
AC5203	UK charger
AC5204	US charger
AC5205	AU charger

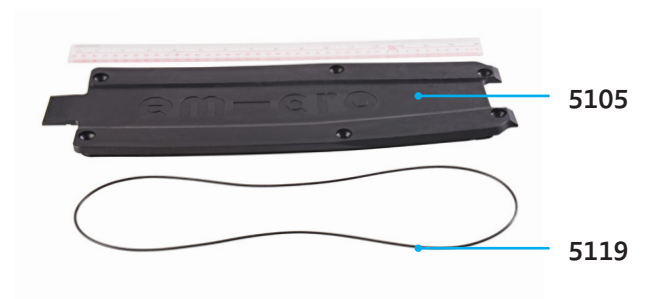
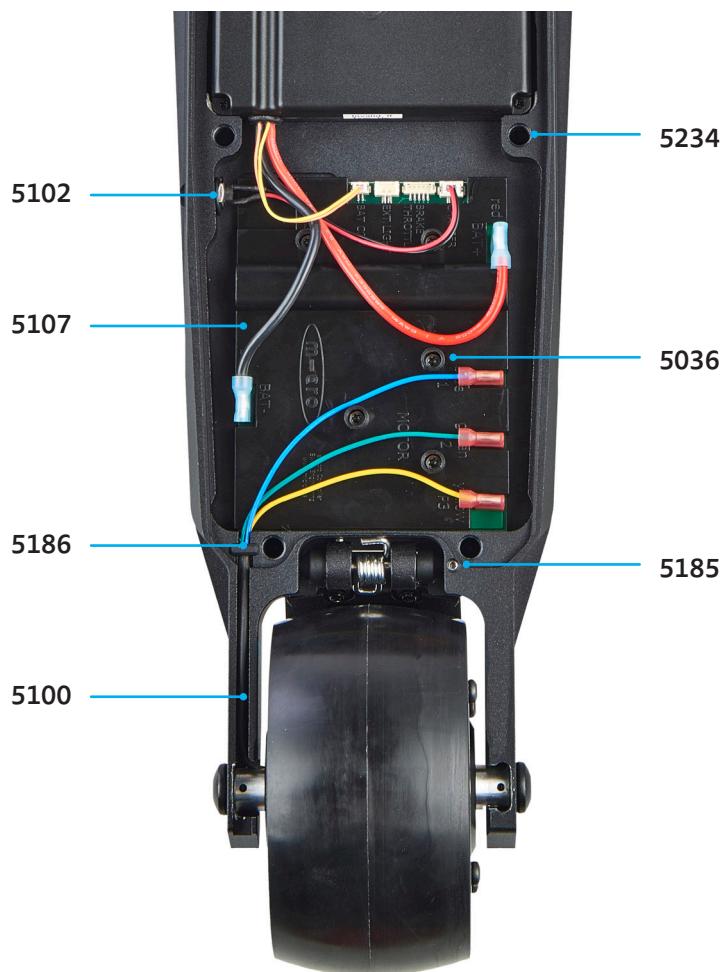
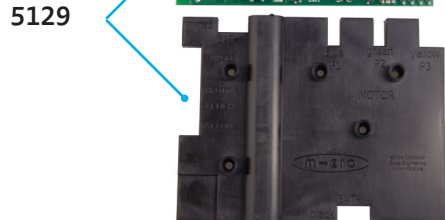
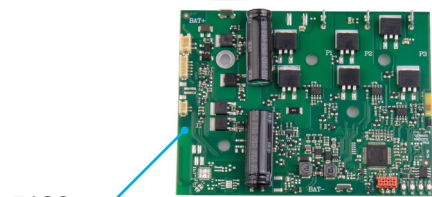
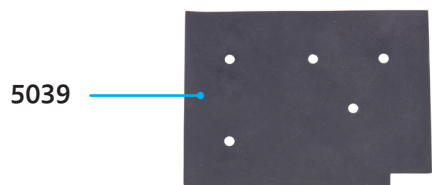
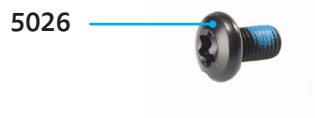



# MICRO FALCON EM0008

## PARTS

article no.	article
5002	handlebar clamp
5003	extension tube
5004	plastic linkage tube
5005	extension tube quick release
5006	lower tube
5007	lower clamp
5010	aluminum spacer ring (hic)
5012	small front wheel fender
5015	spacer front wheel
5016	axle front wheel 150mm
5017	shim (left)
5018	shim (right)
5019	push button blue
5020	bolt for shims (left&right)
5022	folding quick release kit
5023	bolt left + right
5025	M8 countersunk screw folding block left
5026	M8 torx screw
5027	kick stand set
5043	LED plastic cover
5051	rear PU wheel incl. ( Aluminium hub with PU )
5096	small brake complete set V2
5098	brake magnet
5105	small plastic cover
5114	small motor
5116	small griptape

article no.	article
5169	small deck rear light
5182	brake plastic fixture
5183	brake spring
5184	brake pin
5196	small deck main body
5199	spacer ring to small motor (without step)
5222	throttle cable clip
5227	screw for lower clamp
5230	cable cover for folding block
5231	screws for folding block cable cover
5235	M8 motor screw for X3
5238	washer for motor screw (to fit rearlight)
5240	folding block with cable slot
5242	rearlight washer



MICRO FALCON  
EM0008



# MICRO FALCON EM0008

## PARTS

article no.	article
5027	small kickstand set
5036	hexagon socket flat head screws (controller screws)
5039	thermal pad
5076	two-way throttle incl all grips
5091	small frontwheel fender with groove
5099	small throttle cable
5102	charge connector V2
5105	small plastic cover
5119	small o ring
5126	battery V3.2
5129	controller V5 with plastic cover
5169	small deck rear light
5228	small in-deck throttle cable
5230	cable cover for folding block
5231	screws for folding block cable cover
5234	M8 torx cover screws
5235	M8 motor screw for X3
5240	folding block with cable slot
5241	M8 cover screw for Eagle/Condor rearlight
5242	hexagon socket flat head screws
AC5202	EU charger
AC5203	UK charger
AC5204	US charger
AC5205	AU charger

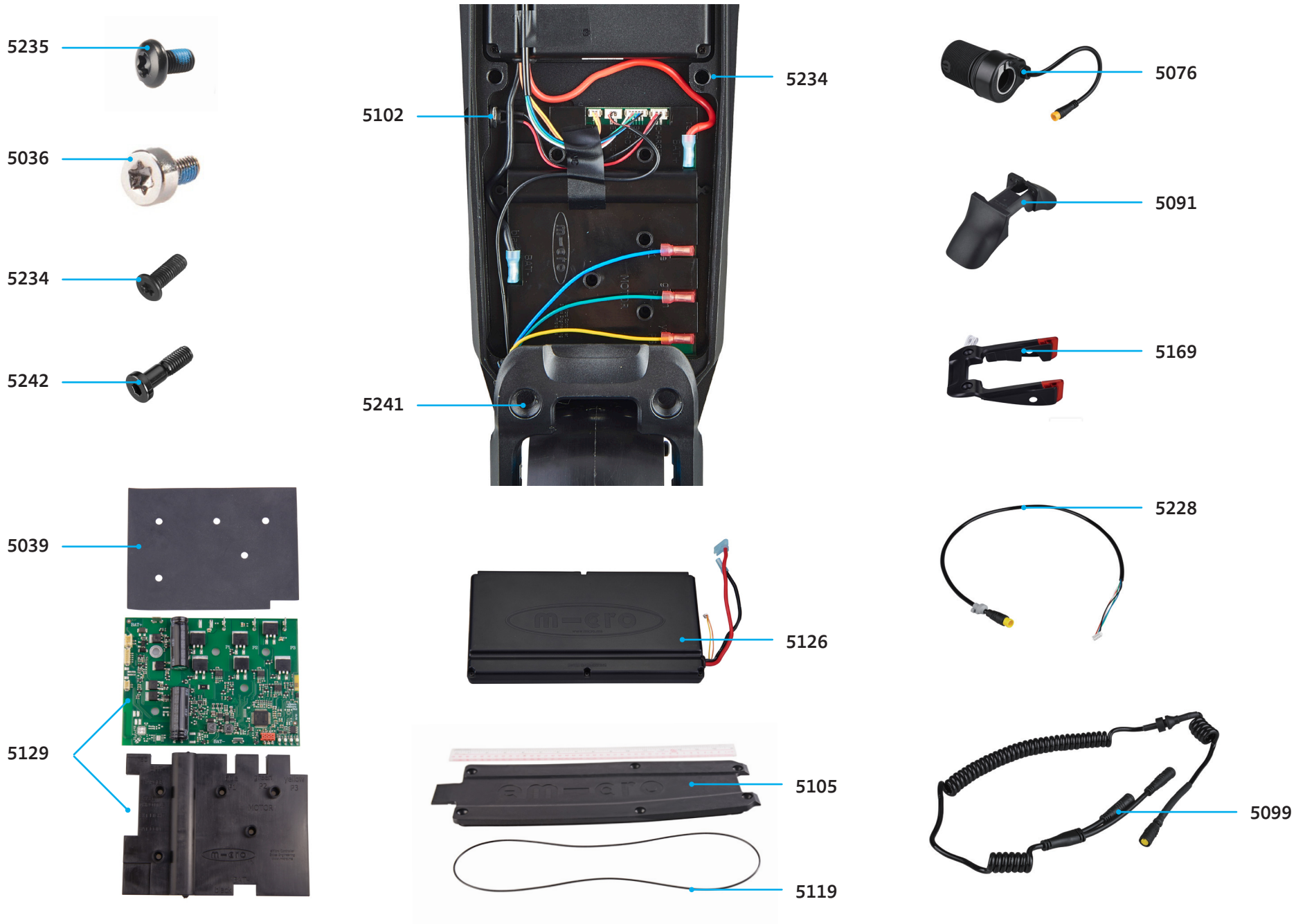

# MICRO EAGLE EM0014

## PARTS

article no.	article
5002	handlebar clamp
5004	plastic linkage tube
5005	extension tube quick release
5007	lower clamp
5012	small front wheel fender
5013	fender front wheel screws
5015	spacer front wheel
5017	shim (left)
5018	shim (right)
5019	push button blue
5020	bolt for shims (left&right)
5022	folding quick release kit
5023	bolt left + right
5043	led plastic protection
5053	allen key
5076	two-way throttle incl all grips
5077	steering head for 200mm scooter
5081	extension tube for 200mm scooter
5083	steel tube cap (HIC)
5087	kick stand set
5089	big fork with holes for frontbrake
5093	big frontwheel fender
5097	large brake complete set
5098	brake magnet
5115	large motor V1
5116	small griptape

article no.	article
5182	brake rubber fixture
5183	brake spring
5184	brake pin
5185	brake fixation screw
5190	medium deck rear light
5197	medium deck main body V1
5215	large lower t-tube
5216	handlebar with cable holes
5217	cable clip
5218	front rubber wheel 200mm incl. brake
5220	brake cable inc sleeve
5222	throttle cable clip
5227	screw for lower clamp
5230	cable cover for folding block
5231	screws for folding block cable cover
5232	brake reflector set
5234	screw folding block left
5235	M8 block motor screw
5238	washer for motor screw (to fit rearlight)
5240	folding block with cable slot
5242	rearlight washer



MICRO EAGLE  
EM0014

# MICRO EAGLE EM0014

PARTS

article no.	article
5036	hexagon socket flat head screws (controller screws)
5039	thermal pad
5076	two-way throttle incl all grips
5087	large kickstart set
5102	charge connector V2
5104	big throttle cable
5119	small o ring
5126	battery V4
5129	controller V5 with plastic cover
5170	large deck rear light
5197	medium plastic cover
5221	frontbrake hand lever
5228	small in-deck throttle cable
5232	brake reflector
5234	M8 torx cover screws
5235	M8 motor screw for X3
5241	M8 cover screw for Eagle/Condor rearlight
5242	hexagon socket flat head screws
5250	front wheel brake
AC5202	EU charger
AC5203	UK charger
AC5204	US charger
AC5205	AU charger

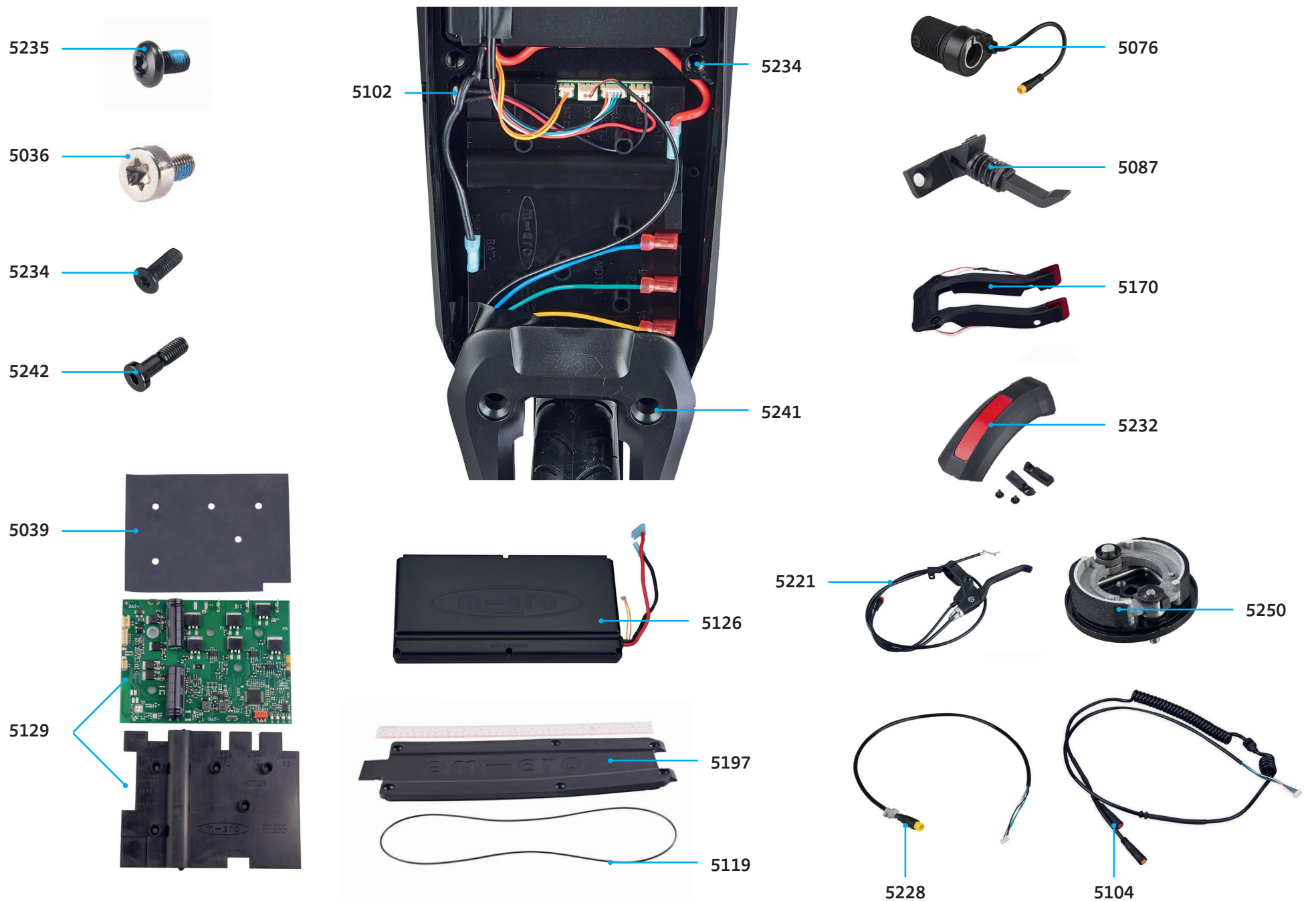

MICRO EAGLE  
EM0014



# MICRO CONDOR EM0016

## PARTS

article no.	article
5001	handles
5002	handlebar clamp
5004	plastic linkage tube
5005	extension tube quick release
5007	lower clamp
5013	fender front wheel screws
5014	frontpart connector screw
5017	shim (left)
5018	shim (right)
5019	push button blue
5020	bolt for shims (left&right)
5022	folding quick release kit
5023	bolt left + right
5087	kick stand set
5043	led plastic protection
5077	steering head
5081	lower tube
5082	large lower t-tube
5083	steel tube cap (HIC)
5089	big fork with holes for frontbrake
5093	big frontwheel fender
5097	large brake complete set
5098	brake magnet
5113	big deck main body V2
5115	motor V4
5118	large griptape
5123	front rubber wheel 200mm

article no.	article
5170	large deck rear light
5182	brake rubber fixture
5183	brake spring
5184	brake pin
5185	brake fixation screw
5216	handlebar with cable holes
5217	cable clip
5218	front rubber wheel 200mm incl. brake
5220	brake cable inc sleeve
5223	front wheel axle
5227	screw for lower clamp
5230	cable cover for folding block
5231	screws for folding block cable cover
5232	brake reflector set
5234	screw folding block left
5235	M8 block motor screw
5238	washer for motor screw
5240	folding block with cable slot
5242	rearlight washer

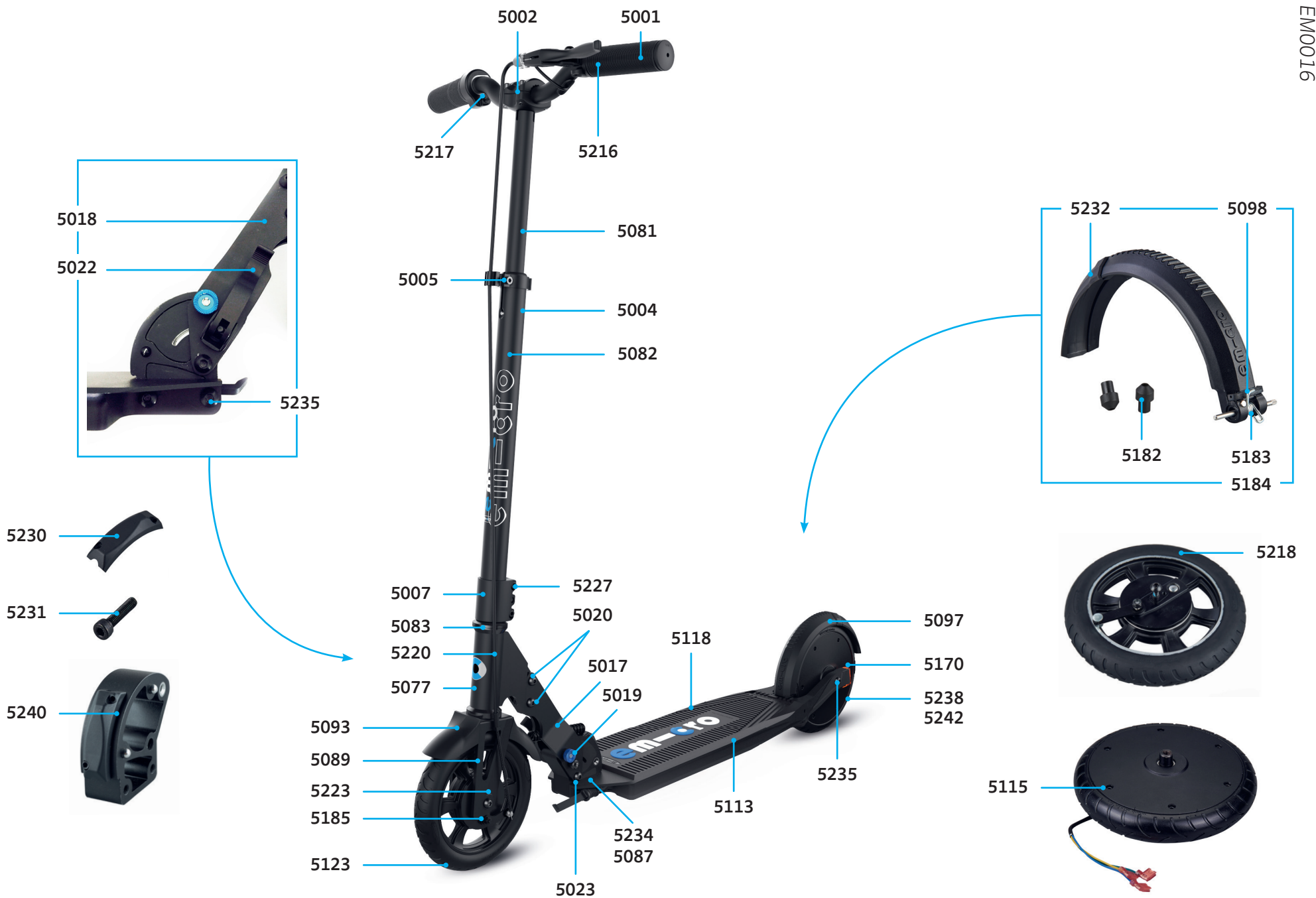

MICRO CONDOR  
EM0016



# MICRO CONDOR EM0016

PARTS

article no.	article
5036	hexagon socket flat head screws (controller screws)
5039	thermal pad
5076	two-way throttle incl all grips
5087	large kickstart set
5102	charge connector V2
5104	big throttle cable
5112	big deck main body V2
5120	big o-ring
5127	battery V4
5129	controller V5 with plastic cover
5170	large deck rear light
5221	frontbrake hand lever
5229	large in-deck throttle cable
5232	brake reflector
5234	M8 torx cover screws
5235	M8 motor screw for X3
5241	M8 cover screw for Eagle/Condor rearlight
5242	hexagon socket flat head screws
5250	front wheel brake
AC5202	EU charger
AC5203	UK charger
AC5204	US charger
AC5205	AU charger

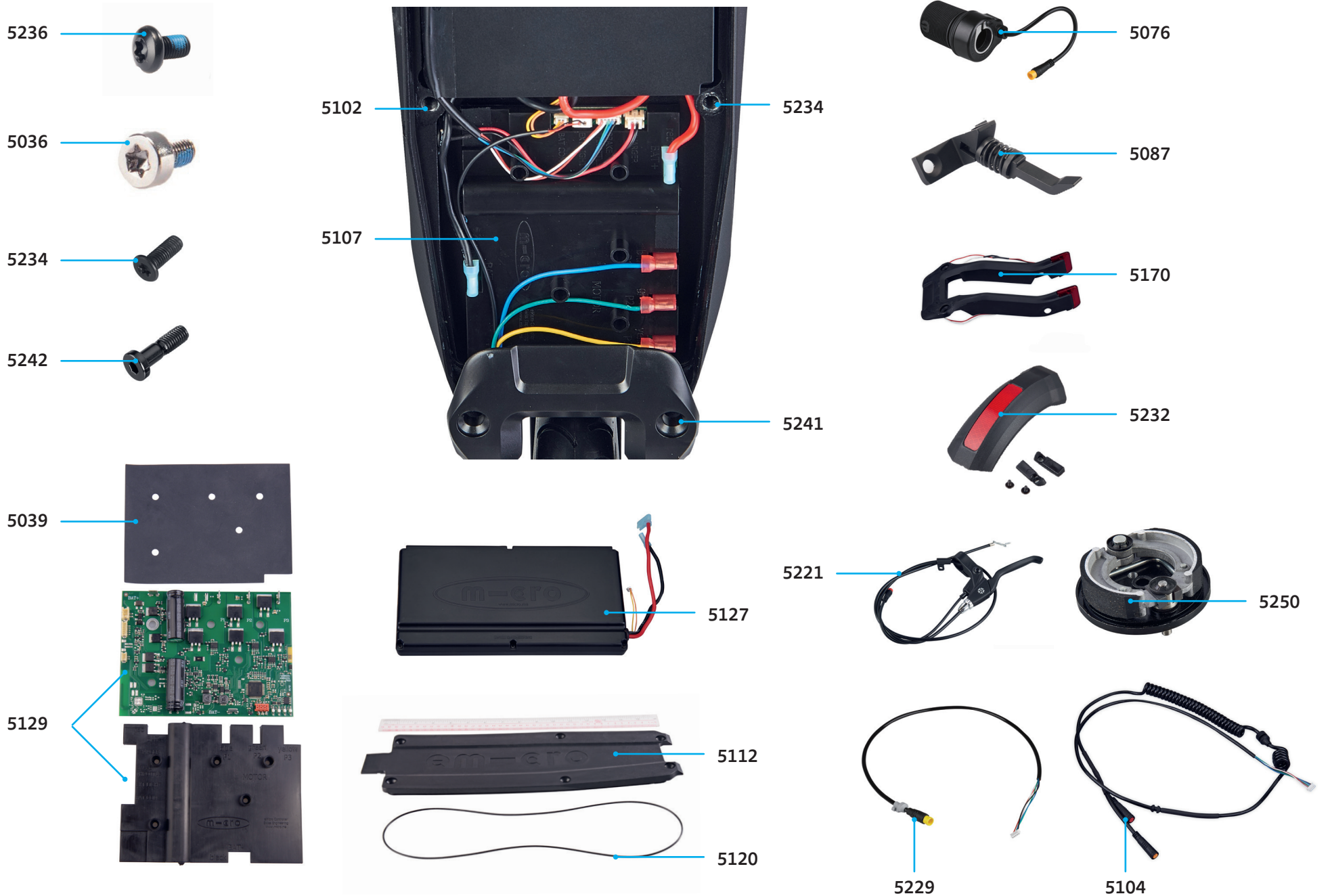

MICRO CONDOR  
EM0016

# MICRO CONDOR II EM0040

PARTS

article no.	article
5473	Brake Cable Set
5476	Front Light Set
5479	Screw Nut for Folding Machnism
5488	Side Reflector Set
5497	Kickstand Set
5826	Handlebar set
5827	Grips Set
5828	Phone Holder Set
5829	Throttle
5830	Brake lever with bell
5831	Full Floding Front Tube Set
5833	Headset
5834	Front Fork Set
5835	Front Fender Set
5838	Disc brake
5839	Front Axle Set
5840	Front Wheel Set
5841	Front Tire Set
5842	Front Reflector Set
5843	Full Deck Set
5845	Deck Front Cover & Bluetooth Set
5846	Grip Tape-Front
5847	Grip Tape-Middle
5848	Grip Tape-Rear
5850	Rear Fender & Light Set

article no.	article
5852	Motor
5853	Rear Tire
5854	Battery Set
SBOX370	Color Box
SBOX371	Master Box

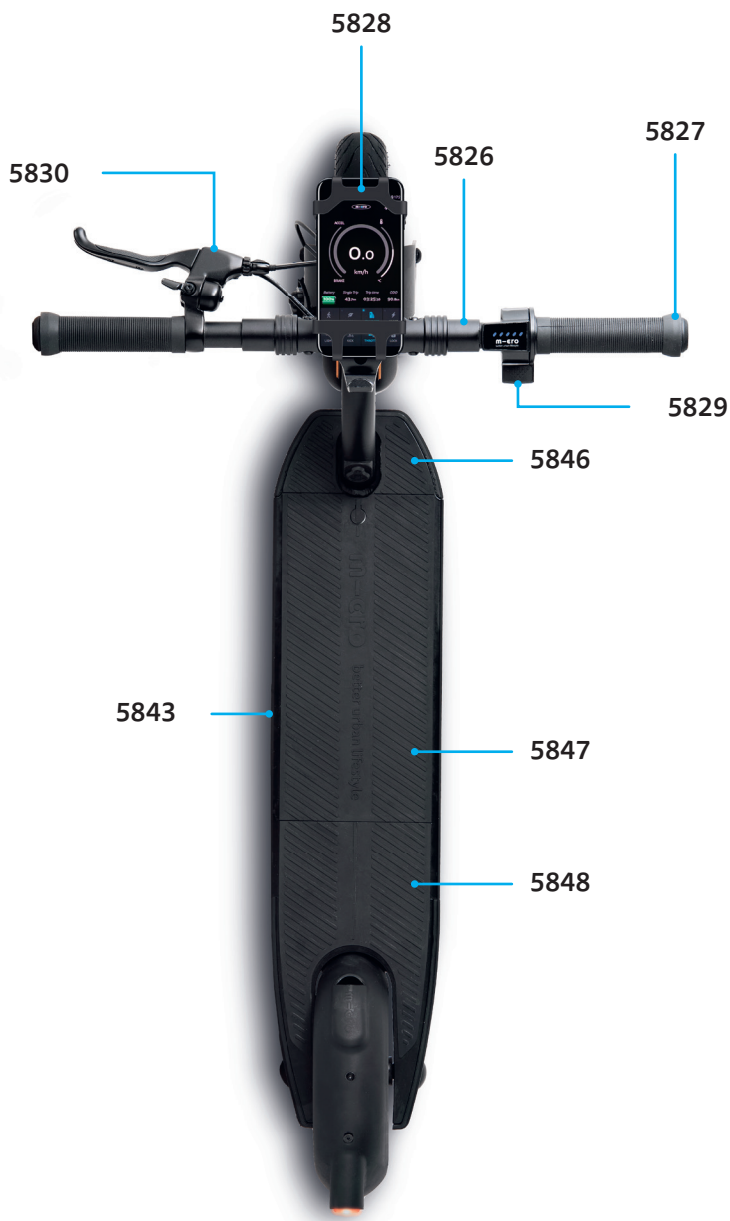

MICRO CONDOR II  
EM0040

# MICRO CONDOR II EM0040

## PARTS

article no.	article
5447	UK charger
5448	AU charger
5449	US charger
5479	Screw nut for folding mechanism
5825	Full Handlebar Set
5832	Full Front Wheel Set
5836	Full disc brake set

article no.	article
5837	Disc brake pads
5844	Charger Cover Set
5849	License Plate
5851	Controller
5855	EU charger
5856	Battery Locker
5857	Main Cable

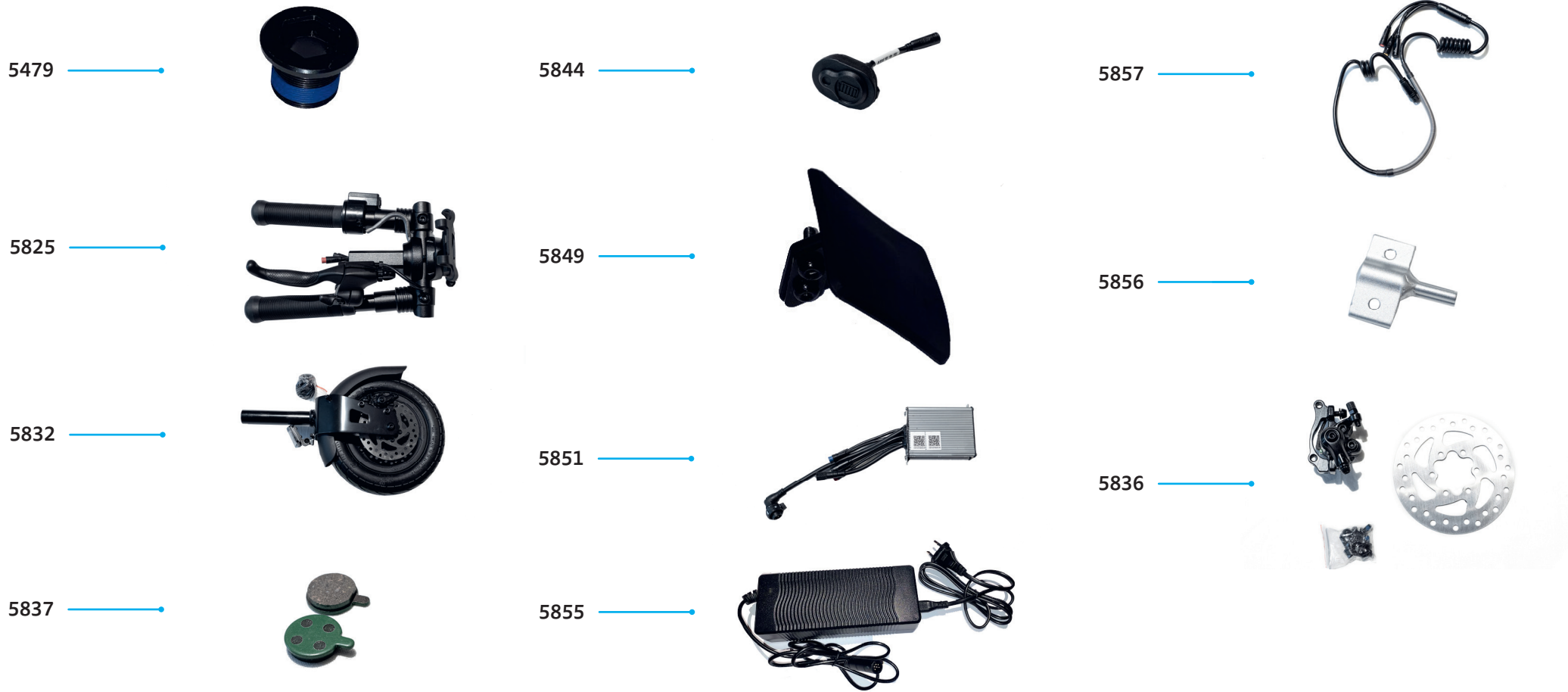



# MICRO EXPLORER EM0036

PARTS

article no.	article
5703	twist throttle set
5704	hand brake set
5705	handle grip
5707	upper clamp set
5709	lower clamp set(include front light)
5712	fornt fork set
5714	square tube set
5717	rear suspension set
5718	rear ears set
5719	rear fender set (include rear light)
5720	motor
5721	drum brake wheels
5722	front ears set
5724	rear cover set
5726	front light
5727	rear light
5728	reflectors
5730	deck four side cover
5731	deck
5732	front fork plastic cover
5084	Micro Logo
5735	BLACK FRONT SUSPENSION COVER

article no.	article
5736	Grip tape
5743	hook for clamp Explorer
5806	Display Explorer DE (Max speed 22km/h, no secret code)
5807	Display Explorer CH (Max speed 25km/h, with secret code)
5808	Display Explorer EU with secret code (Max speed 25km/h, with secret code)
5865	Display Explorer FR (Max speed 25km/h, no secret code)
DP0040	Micro Explorer POS Foldable Carton Display
SBOX366	Masterbox Explorer



MICRO EXPLORER  
EM0036



# MICRO EXPLORER EM0036

# MICRO MERCEDES

PARTS

article no.	article
5700	T-pipe control set
5701	t-pipe set (mechanical)
5706	power module set
5708	Aluminum tube set
5710	Tube set inside
5711	full square tube control set
5713	Steering tube set
5715	conroller set
5716	Full rear fork set
5723	Front cover set
5729	Battery

article no.	article
5734	Mercedes star
5737	Mercedes grip tape
5738	EU charger
5443	UK charger
5444	AU charger
5445	US charger

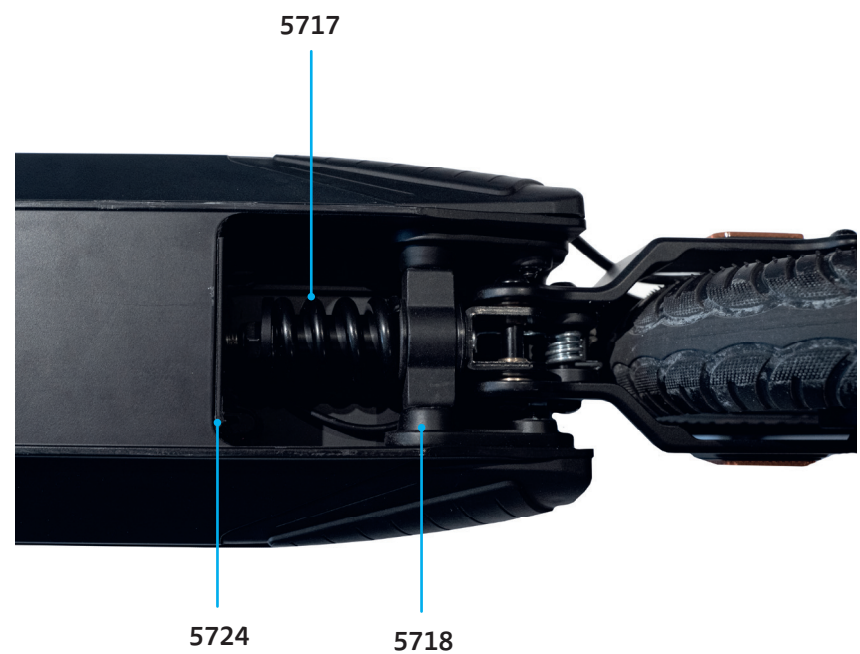
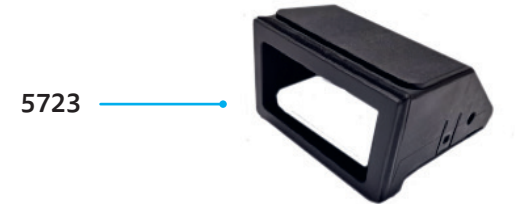
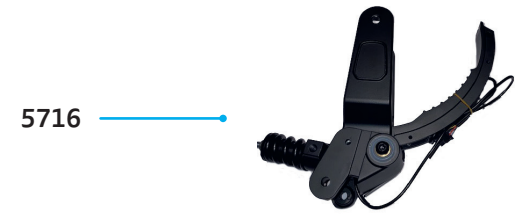
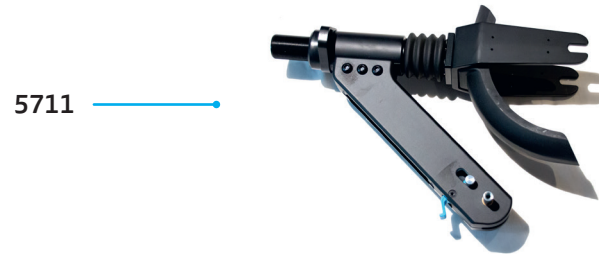

MICRO EXPLORER  
EM0036

# MICRO COLIBRI EM0018

## PARTS

5601	article
5463	Brake lever with bell
5476	Front light incl. holder & screws
5477	Nut, Screw
5480	Upper Cap, Lower Junk Ring, Bearing
5481	Front Fork Set
5482	Front Fender Set
5483	Front Wheel Set
5488	Side Reflector
5494	Motor Nut Protective Cap
5497	Kickstand set
5498	Charger Cover Set
5505	Front Axle
5506	Motor nuts
5525	Throttle
5526	Stem lower cap, Stem upper cap
5527	Front Tube
5528	Deck+ Griptape
5529	Grip tape

article no.	article
5530	Rear Fork Set
5600	Phone holder fixed plate
5601	Phone holder
5603	Front tube with stickers / folding machnism & main cable
5880	Wheel Coat
SBOX324	Color Box
SBOX325	Master Box



# MICRO COLIBRI EM0018

# MICRO BMW EM0031

PARTS

article no.	article
5523	Handlebar with thumb throttle
5524	Grip
5462	Throttle
5464	Front reflector
5485	Deck
5489	Griptape
5492	Rear fork set
5470	Front tube + folding + cables
5471	Cable plug
5474	Main cable to front light & Neck cable
5475	Adapter cable from neck to battery
5479	Hexgon screw nut
5484	Full front fork + wheel + fender
5493	Rear Brake incl. Hall sensor set + Light
5499	EU charger
5500	UK charger
5501	US charger
5502	AU charger
5522	Full handlebar set

article no.	article
5459	Full handlebar set
5460	Handlebar with thumb throttle
5461	Grip
5462	Throttle
5465	Stem completed incl. Folding hook & screws
5470	Front tube with stickers / folding machnism & main cable
5485	Completed Deck with grip tape, w/o side reflectors
5489	Grip Tape
5492	Rear Fork
5432	EU charger BMW

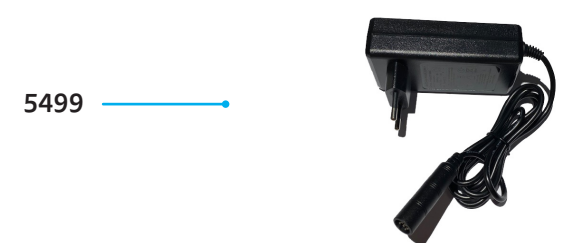
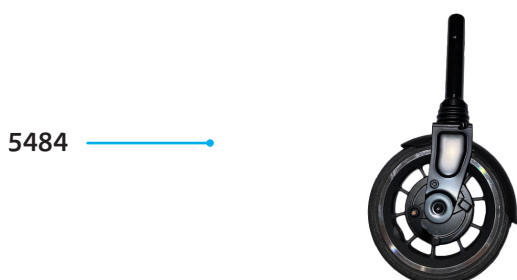

MICRO COLIBRI  
EM0018



# MICRO E-BIKE 16" EB0002

**PARTS**

5601	article
5626	Battery(Lion) 4000mAh Power Bank type, Removable
7042	Motor (Real wheel assembly) Complete with tire and inner tube)
7043	Sensor
7044	Brake Lever left/right
7045	Front Reflector (White)
7046	Rear Reflector (Red)
7047	Handle grip (set 2pcs)
7048	Battery mount support
7049	Handle Bar with grips
7052	Front Mudguard
7053	Rear Mudguard
7054	Saddle
7055	Seat tube
7056	Front wheel complete
7057	16 inch Tire (Rear/front)
7058	16inch inner tube (Rear/front)
7059	Pedals set (2pcs)
7060	Wheels reflectors
7061	Brake pads (2pcs)
7063	Chain
7064	Quick Release clamp saddle steam

article no.	article
7065	Quick Release clamp handlebar
7066	Freewheel (Multiple 6-speed
7069	Bell
7070	Kickstand
7071	Rubber Gasket cables
7073	Spiral Binding
7074	Complete front brake with cables
7075	Complete rear brake with cables
7076	Head set
7087	Shifting cable
7088	New Controller
7089	Matt front fender
7090	Matt rear fender



MICRO E-BIKE 16"  
EB0002



# MICRO E-BIKE 16" EB0002

## PARTS

article no.	article
7040	Controller
7050	Upper tube
7051	Lower tube with foldin joint
7062	Chain Wheel
7067	Frame Latch plastic lock
7072	EU charger
7080	UK charger
7106	Gear shifter
7107	Twist shifter for handle



MICRO E-BIKE 16"  
EB0002

# MICRO MERLIN WITH HANDBRAKE: EM0049

PARTS

5601	article
5084	Micro Logo
5308	Handgrips
5332	Rear Suspension
5344	Clamp
5346	Pushbutton
5305	Rubber Shock Cover
5324	Throttle L+R
5331	Front Motor
5336	Front Ears
5349	Rear Brake Wire
5350	Rear Light Wire
5351	Throttle Wire
5387	clamp and Screws
5389	Front Fork with Suspension
5390	Deck
5391	Rubber
5431	Battery
5508	Rear Ear with Spacer and Axle
5509	Whole Square Tube with Screws
5510	Steering Tube with Screws
5511	Front Fork Cover with Screw
5514	Front Fender with Screws
5515	Front and rear Cover with Screws
5518	Reflector stickers
5531	handbrake with brake wires and brake cable
5532	drum brake wheels
5533	T-pipe Set (handbrake version)

article no.	article
5534	Rear Wheel axle
5535	Wires holder
5536	Display with cover and screws
5537	rubber support reflector
5538	rear fender with screws (fit rubber support reflector)
5540	side reflector
5543	Rear fork

# MICRO MERLIN WITHOUT HANDBRAKE: EM0019

article no.	article
5303	Rear fender with rear light
5314	Controller
5315	Rear fork set
5316	T-Pipe set
5329	Rear wheel



MICRO MERLIN  
EM0049

# MICRO MERLIN WITH HANDBRAKE: EM0049

## PARTS

article no.	article
5312	EU charger
5253	UK charger
5255	US charger
5257	AU charger
5389	Front suspension set
5334	Wires holder
5351	Throttle wire
5336	Front Ears
5441	Controller with motorbrake
5539	Controller no motorbrake
5542	Rear fork set
5508	Rear ears set
5881	Safety pin for the handlebar
5873	Controller CH Version

5312



5539  
5441  
5873



5542



5336



5508



5881



5389



5334





# MICRO SPARROW XL EM0017

## PARTS

article no.	article
5412	Handlebar with thumb throttle and grips
5404	Front tube set
5413	Front fender set
5405	Deck incl. head & neck tube welding with head badge
5406	Rear fork set
5407	Grip tape
5275	Front wheel incl. screw & nut
5276	Front cover incl. screw
5277	Rear brake set with reflector sticker
5414	Lower clamp
5408	EU Charger 24V
5409	UK Charger 24V
5299	US Charger 24V
5300	AU Charger 24V
5415	Stem incl. screw
5416	Fork set
5400	Battery + Motor + Controller set incl. Hall sensor
5410	Kickstand only /10 sets incl.
5417	Charger cover w/holder & screw /50set incl.
5285	Deck screw /200pcs incl.
5294	Motor nut protective cover /100pcs incl.
5295	Front wheel axle screw set /200pcs incl.
5296	Hall sensor screw /50pcs incl.
5282	Grips
5288	Screws for kickstand /50pcs incl.
5289	Bolt & Spring for fender brake /50 sets incl.
5401	Motor Tire Set
5402	Throttle

article no.	article
5403	Throttle Cable Adapter
5418	Deck Protective Cover
Sbox310	Color Box for Sparrow XL
5291	„Bluetooth (For Diagonise tool)“
5293	Wheel bearings /40pcs incl.



MICRO SPARROW  
EM0017

# MICRO SPARROW EM0017

## PARTS

article no.	article
5270	front tube
5271	front fender set
5272	deck set
5273	rear fork
5274	grip tape
5275	front wheel
5276	front deck cover
5277	rear brake complete
5278	lower clamp
5279	stem with screws
5280	fork complete
5281	battery & motor set incl. hall sensor
5282	grip
5290	handlebar set
5284	kickstand with screws
5285	deck screws set
5287	front wheel axle
5288	screws kickstand
5289	bolt and spring for brake
5297	EU charger
5298	UK charger
5299	US charger
5300	AU charger
5292	Charger Cover
5293	Wheel Bearings
5294	Motor nut protective cover
5295	Front wheel axle screw set
5296	Hall sensor screw

